

Go into the village in front of you, and immediately you will find a donkey tied, and a colt with her. Untie them and bring them to Me. If anyone says anything to you, you shall say,

"The Lord needs them," and he will send them at once.

Matthew 21: 2-3

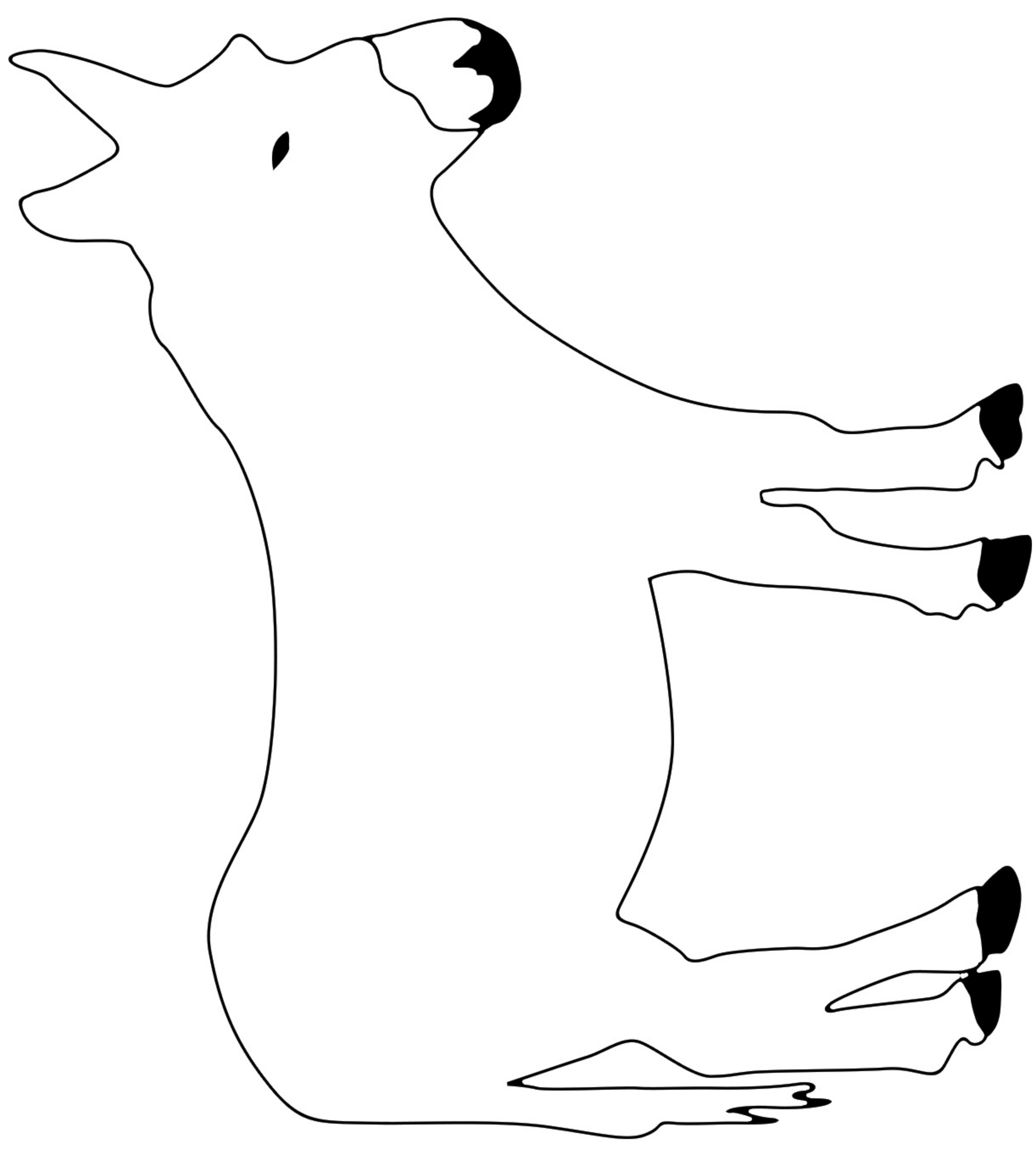
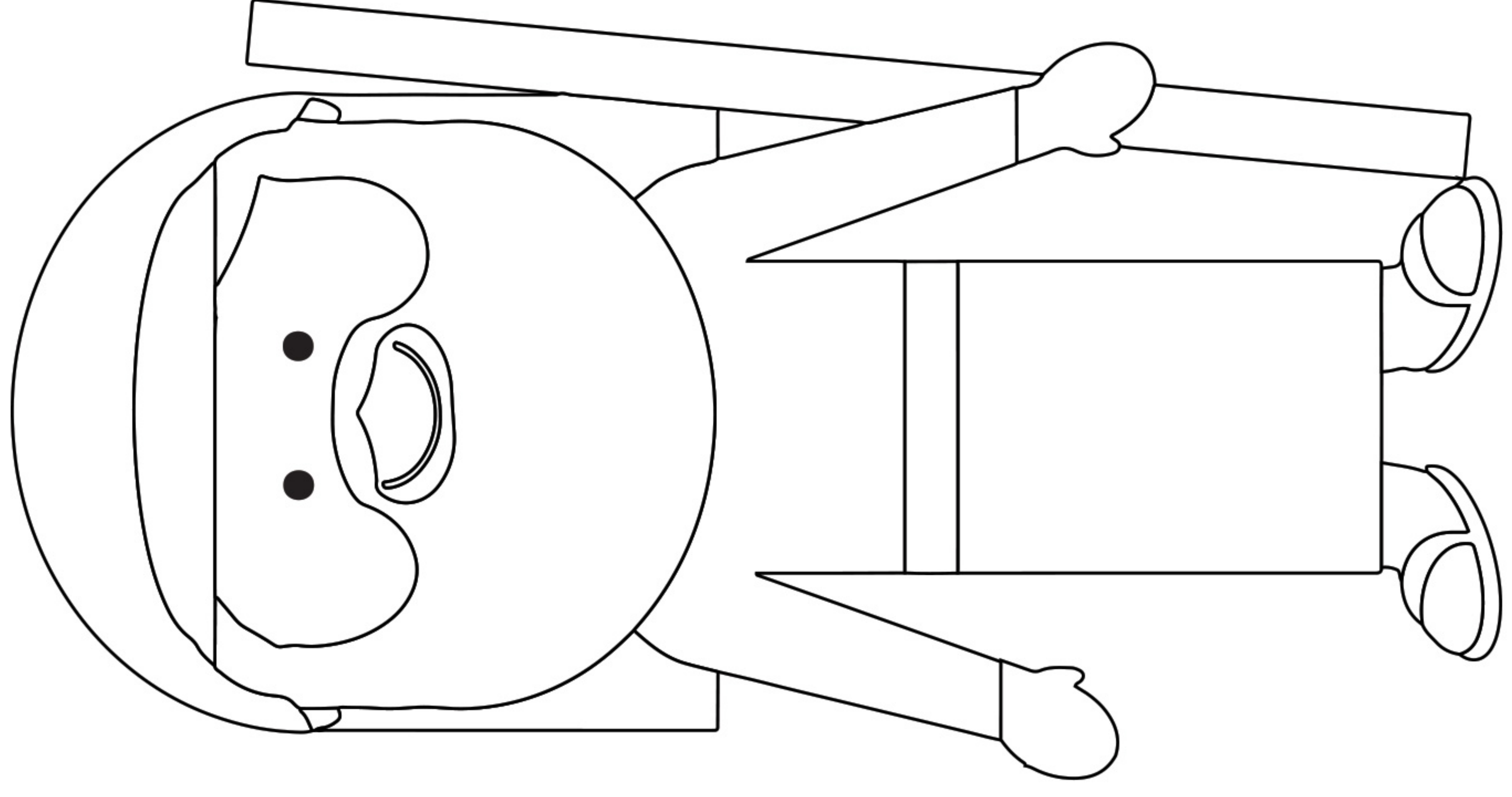
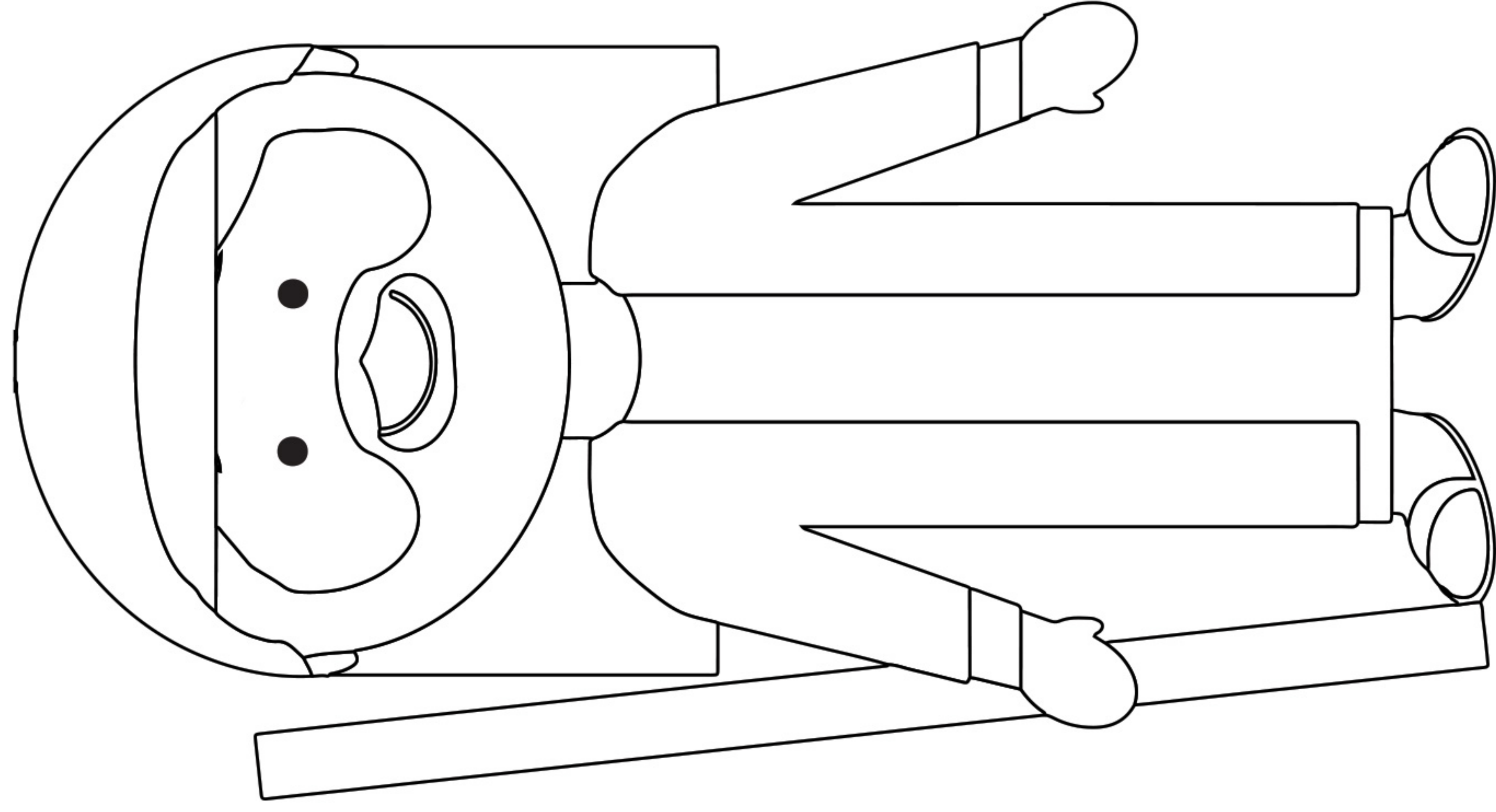

Then one of the Twelve, the one called Judas Iscariot, went to the chief priests and asked, "What are you willing to give me if I give him over to you?". So they counted out for him thirty silver coins. From then on Judas watched for an opportunity to hand Him over.

Matthew 26: 14-16

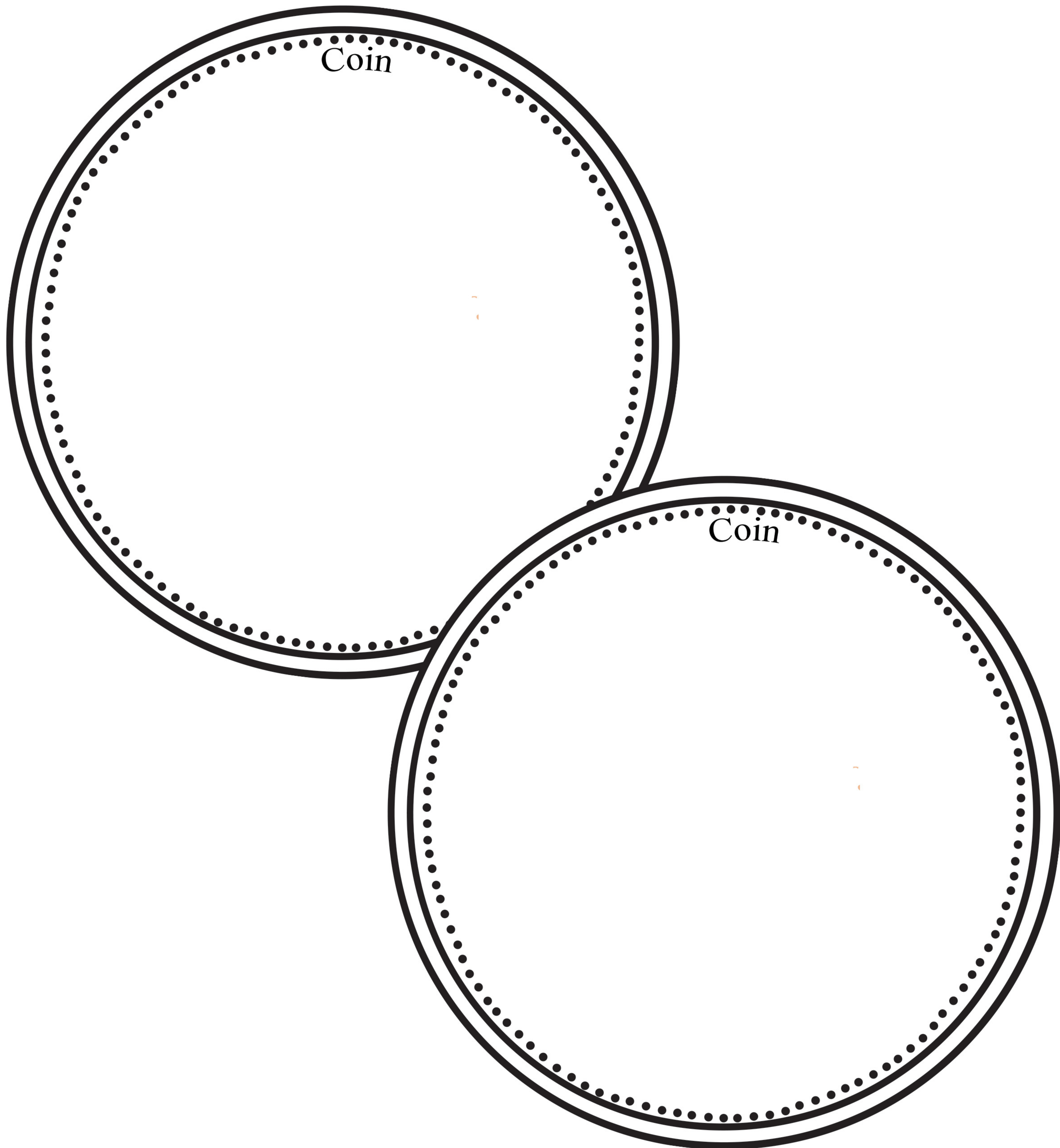

And He took a cup, and when He had given thanks He gave it to them, saying,
“Drink of it, all of you, for this is My blood of the covenant,
which is poured out for many for the forgiveness of sins.”

Matthew 26: 27-28

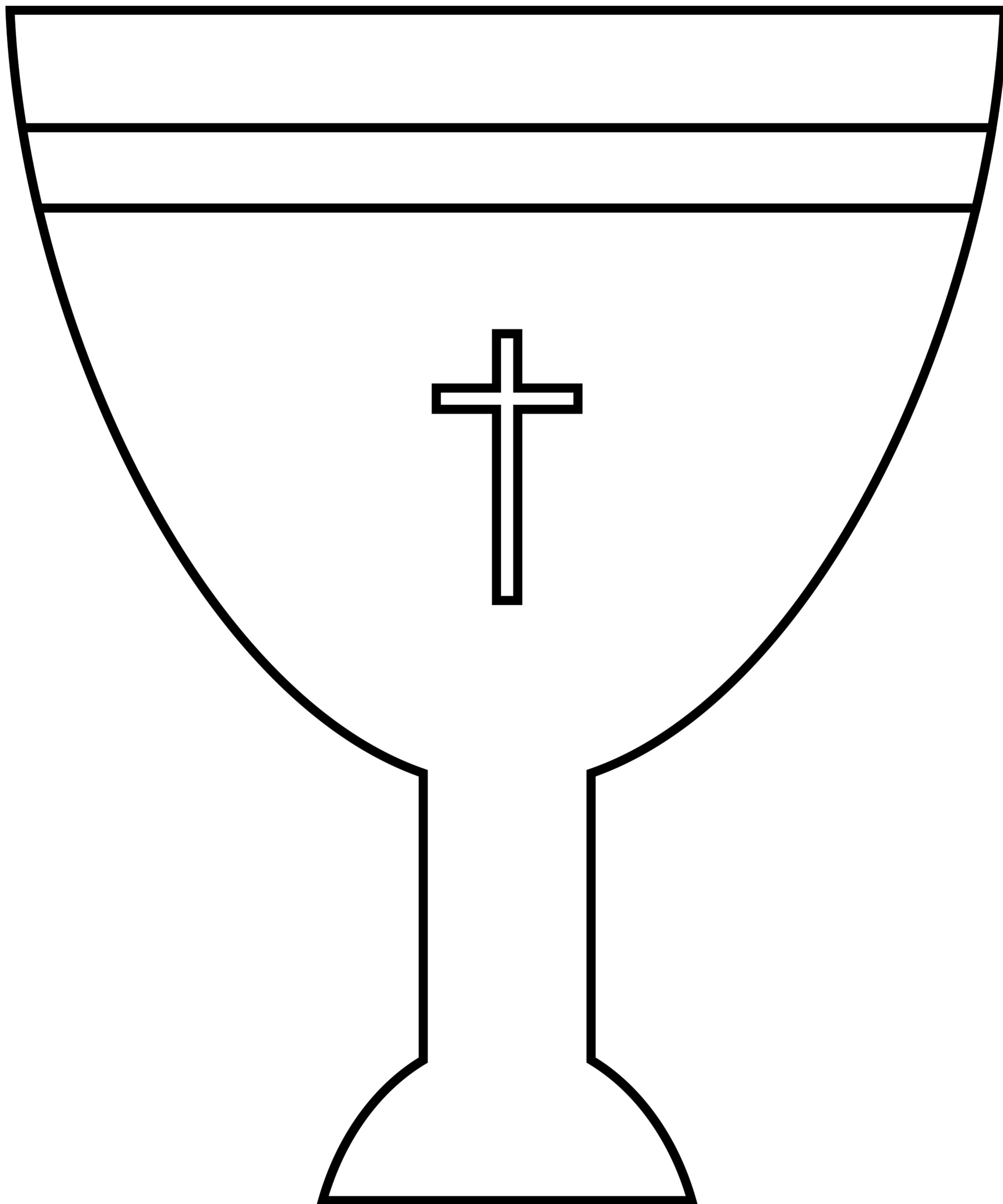

And they went to a place called Gethsemane. And He said to His disciples,
“Sit here while I pray.” And He took with Him Peter and James and John,
and began to be greatly distressed and troubled. And He said to them,
“My soul is very sorrowful, even to death. Remain here and watch.”

Mark 14: 32-34

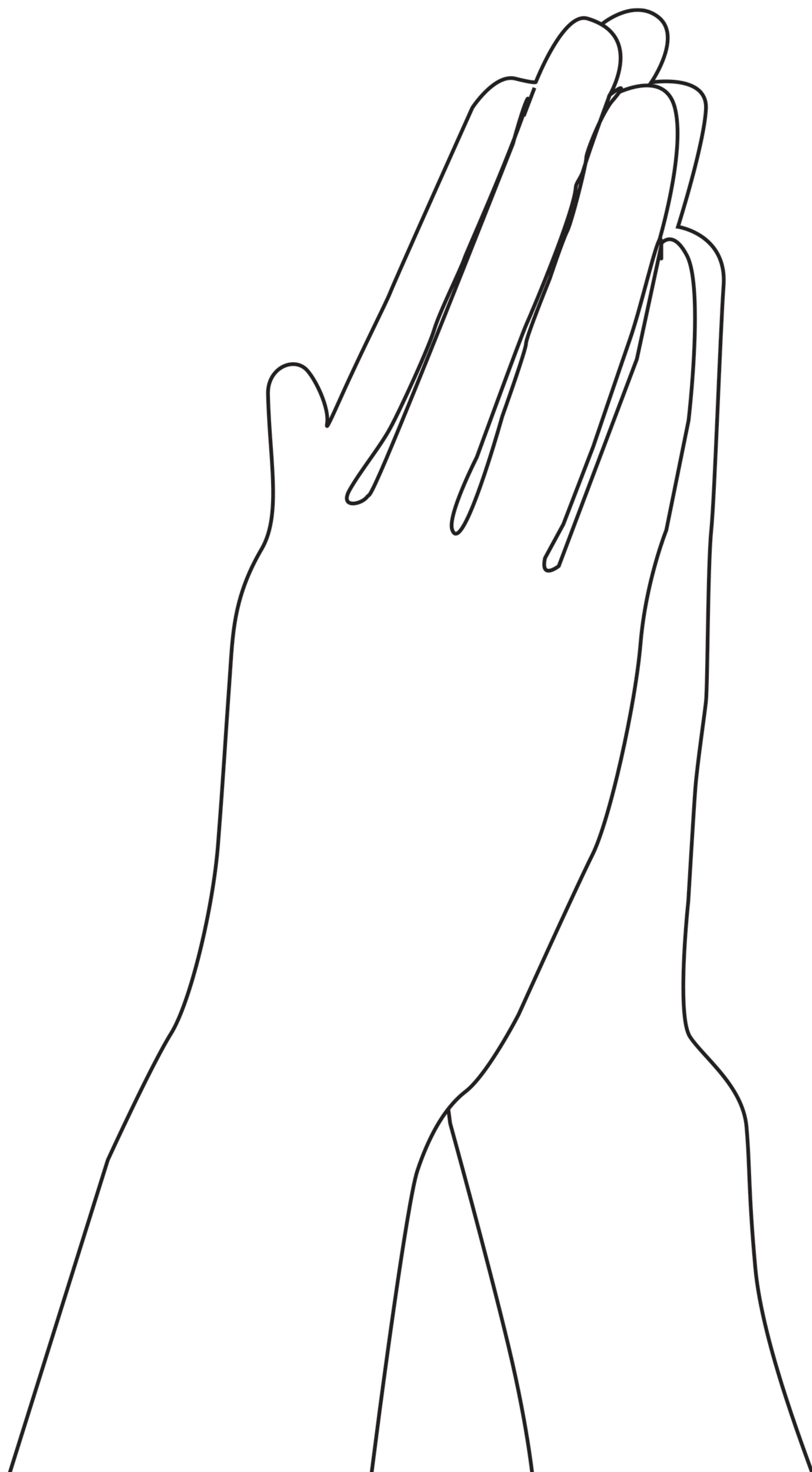

Then Pilate took Jesus and flogged {whipped} Him.
John 19:1

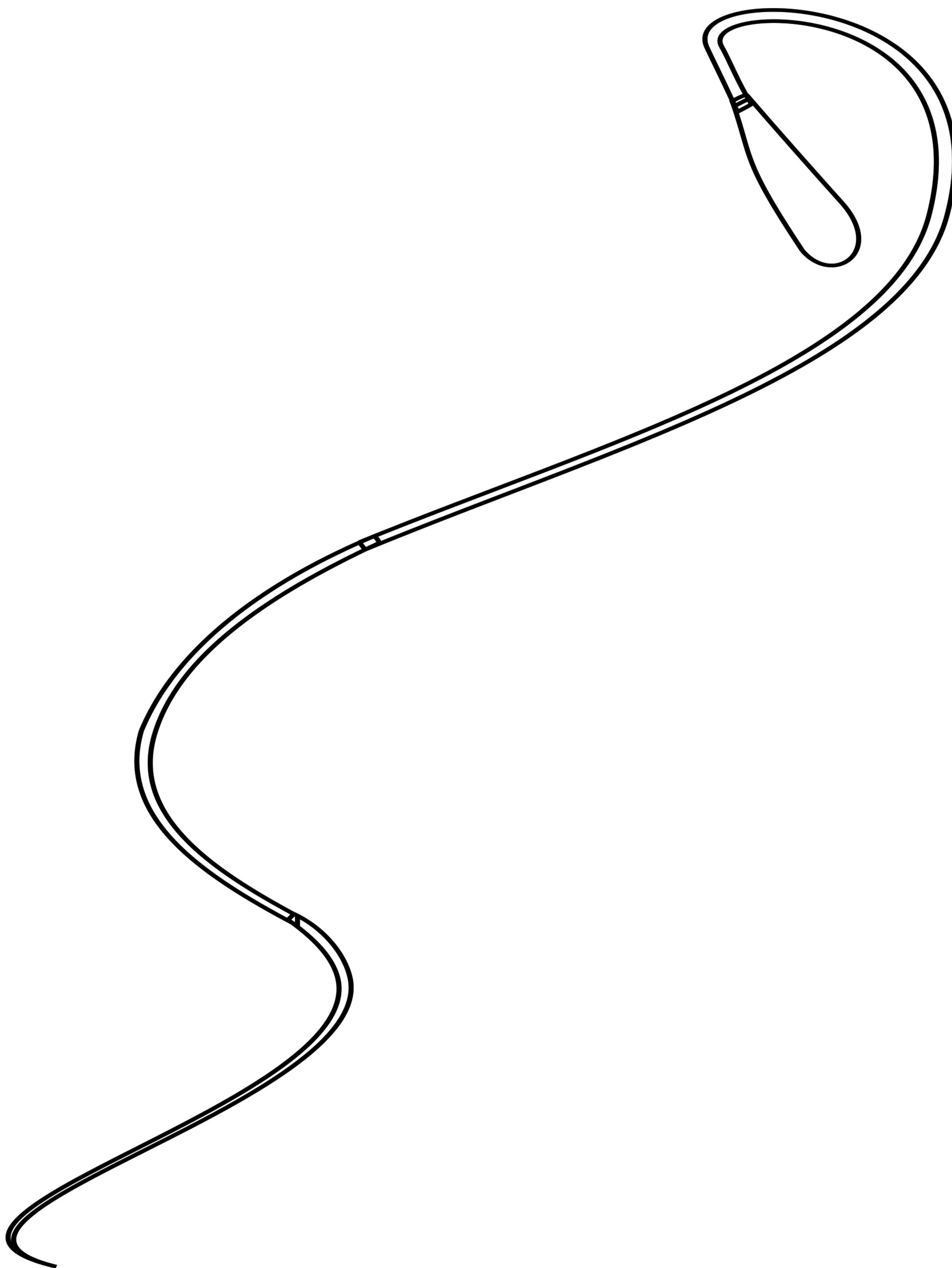

Then the soldiers of the governors took Jesus into the governor's headquarters...
and twisting together a crown of thorns, they put it on His head...
and kneeling before Him, they mocked him.

Matthew 27: 27-29

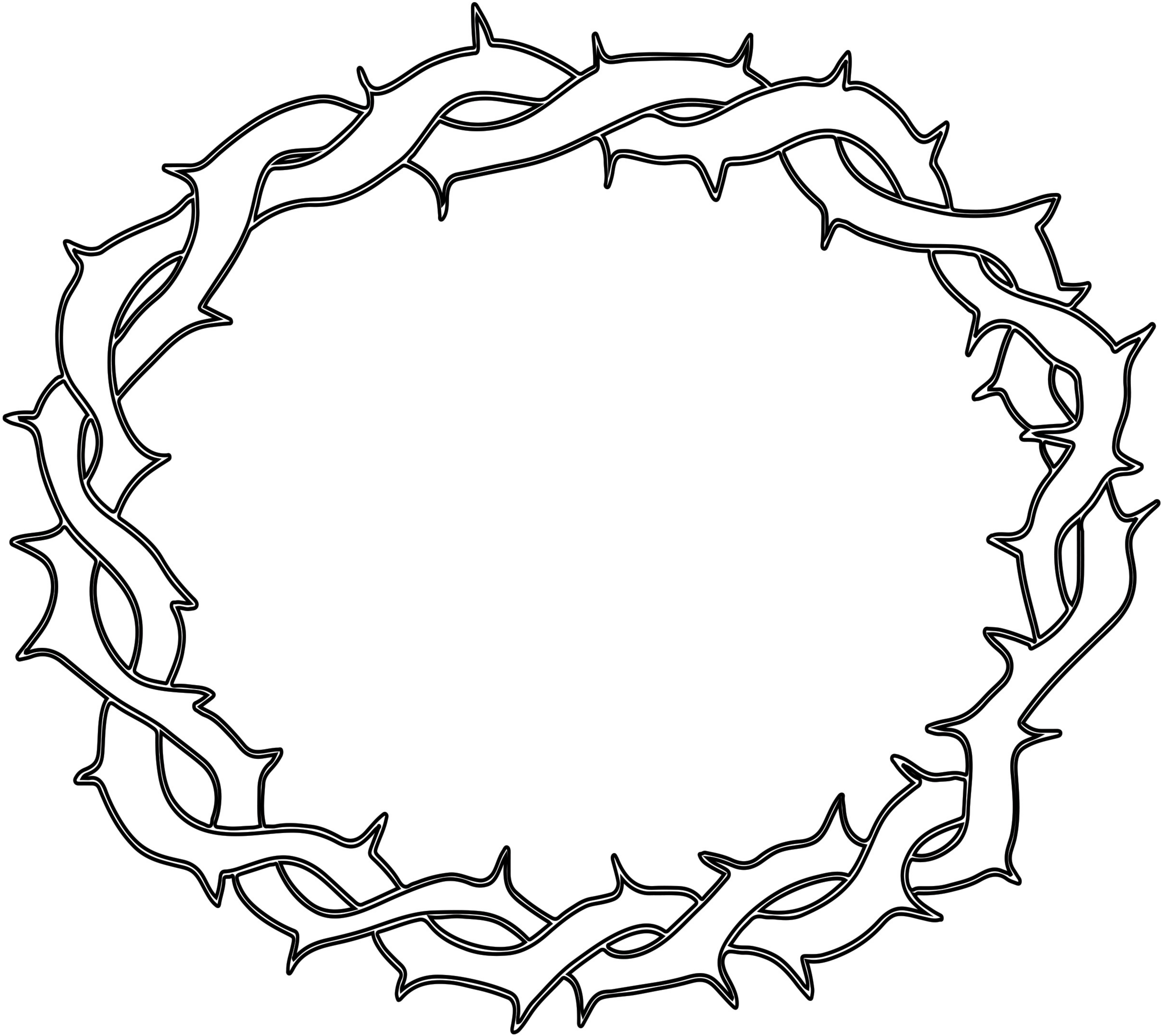

So they took Jesus, and He went out, bearing His own cross, to the place called the place of a skull, which in Aramaic is called Golgotha. There they crucified Him, and with Him two others, one on either side, and Jesus between them.

John 19: 16-18

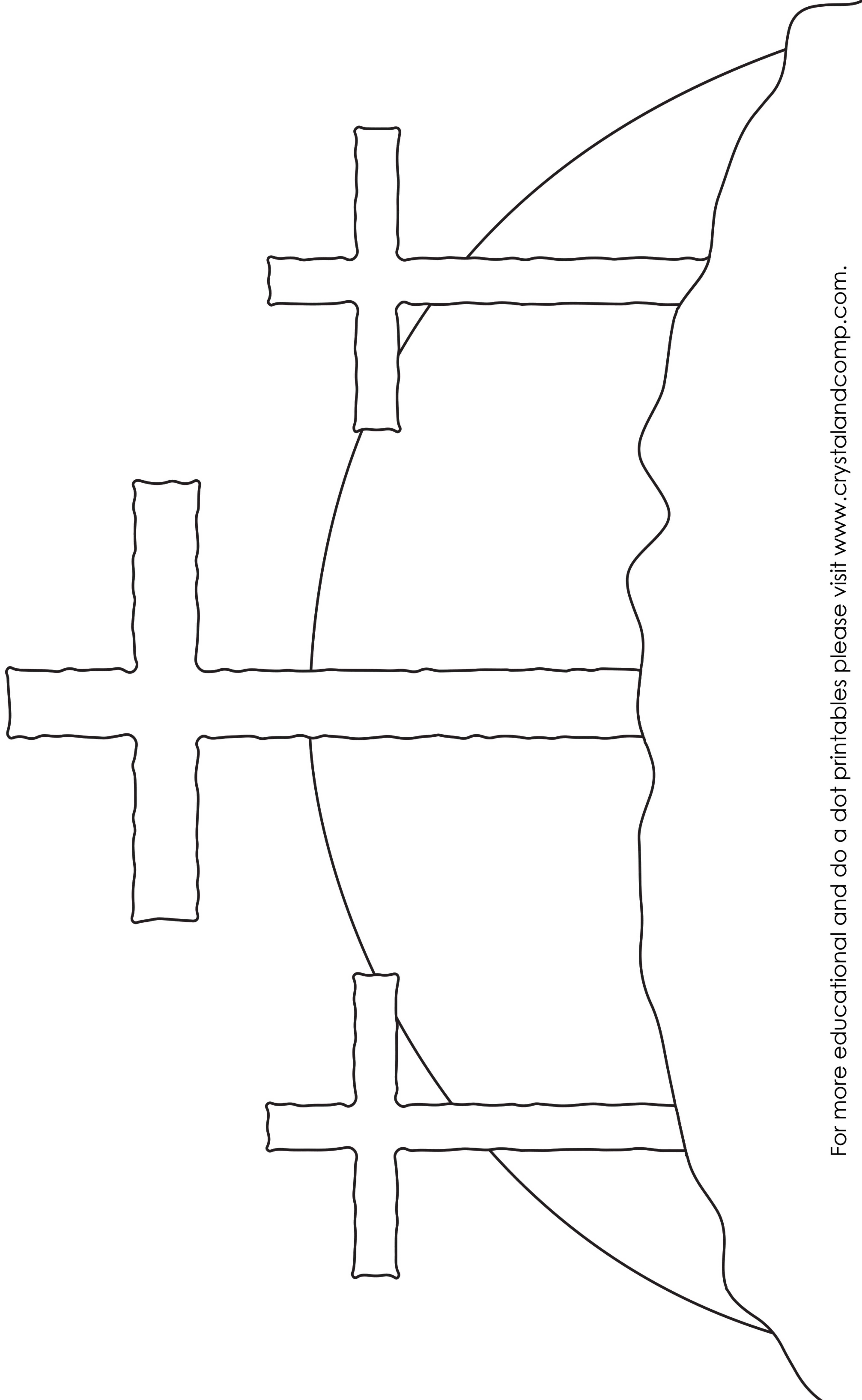

When the soldiers had crucified Jesus, they took His garments and divided them into four parts, one part for each soldier; also His tunic.

But the tunic was seamless, woven in one piece from top to bottom, so they said to one another, “Let us not tear it, but cast lots for it to see whose it shall be.”

John 19: 23-24

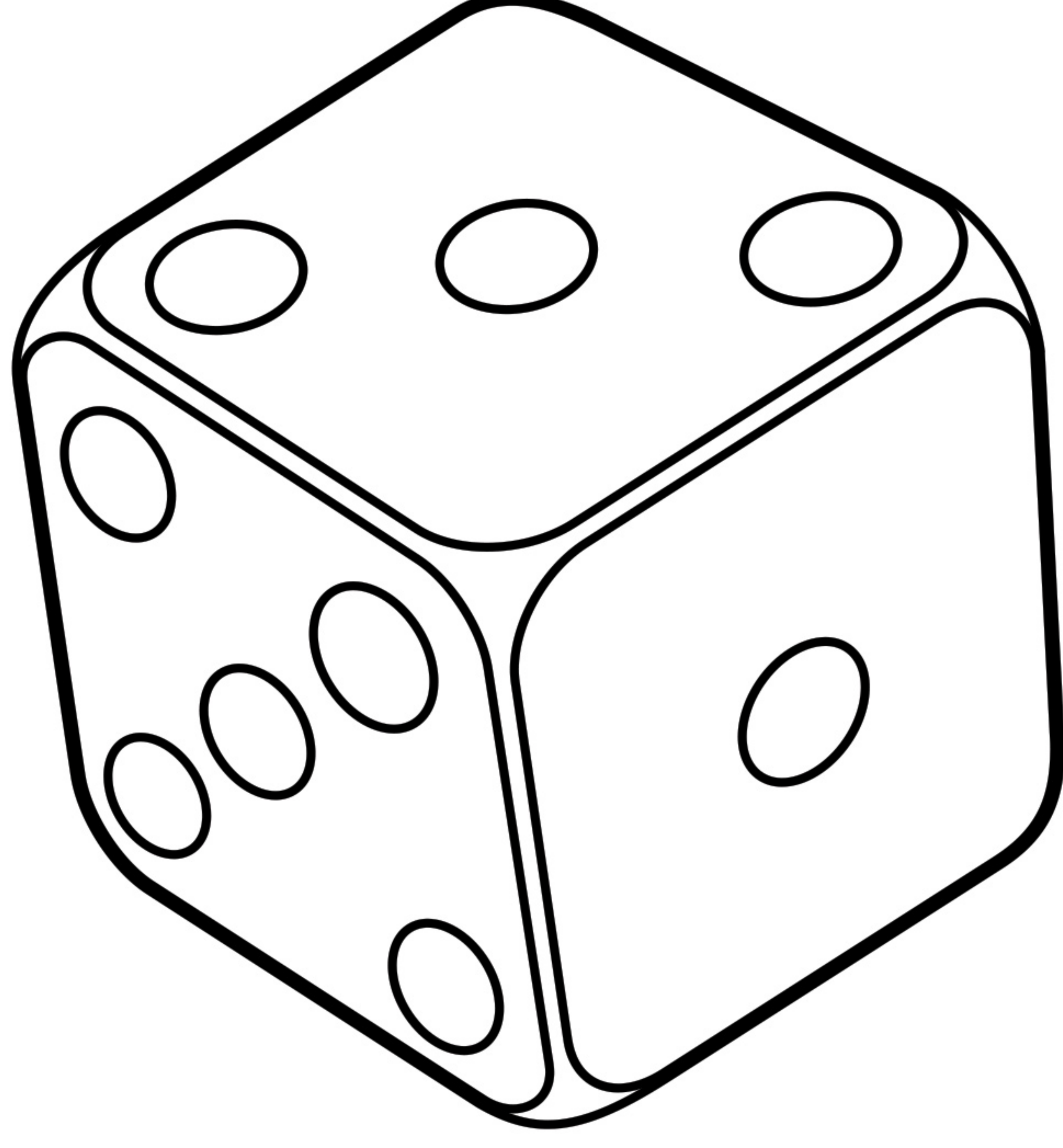
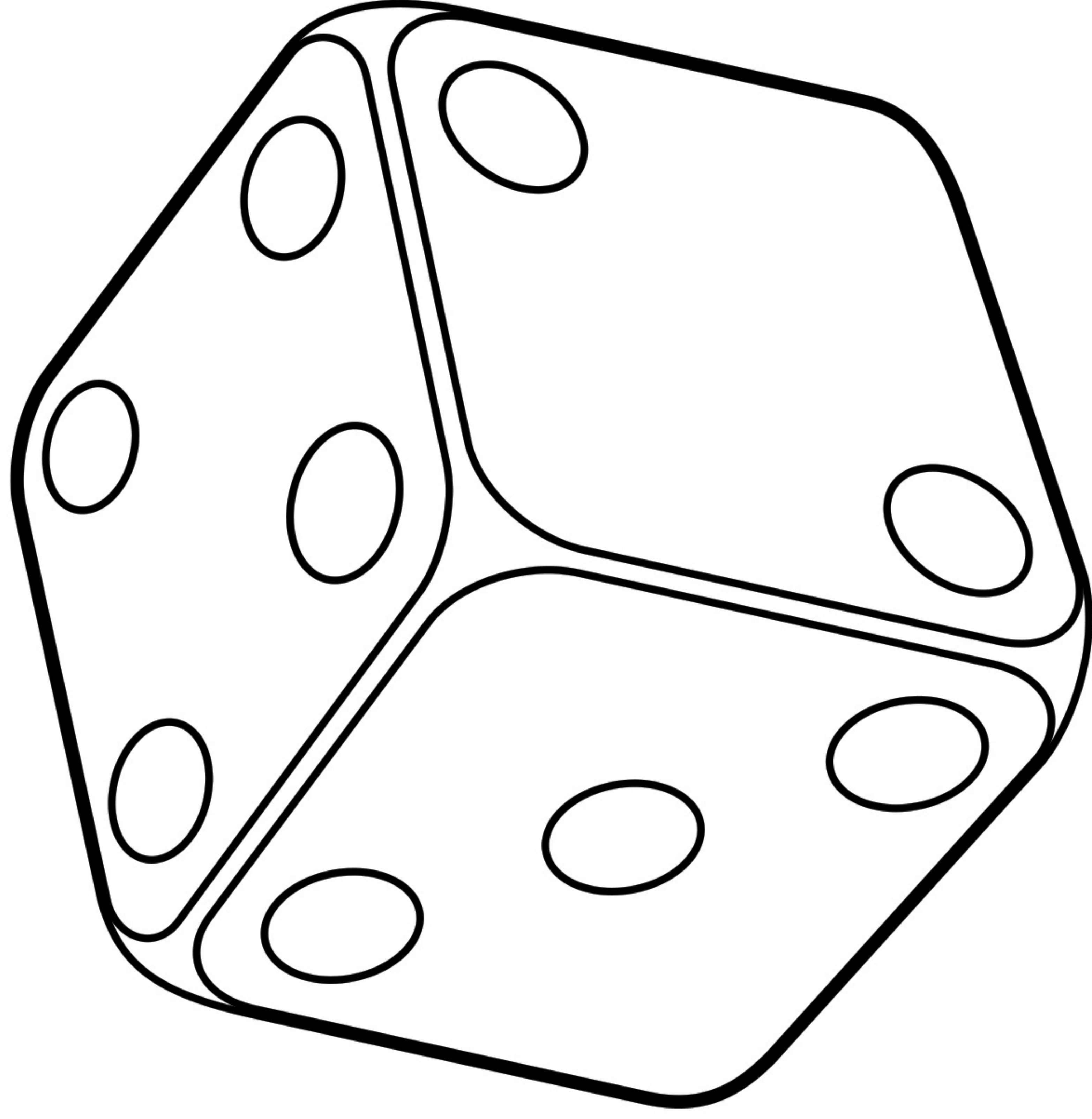

So the soldiers came and broke the legs of the first, and of the other who had been crucified with Him. But when they came to Jesus and saw that He was already dead, they did not break His legs. But one of the soldiers pierced His side with a spear, and at once there came out blood and water.

John 19: 32-34

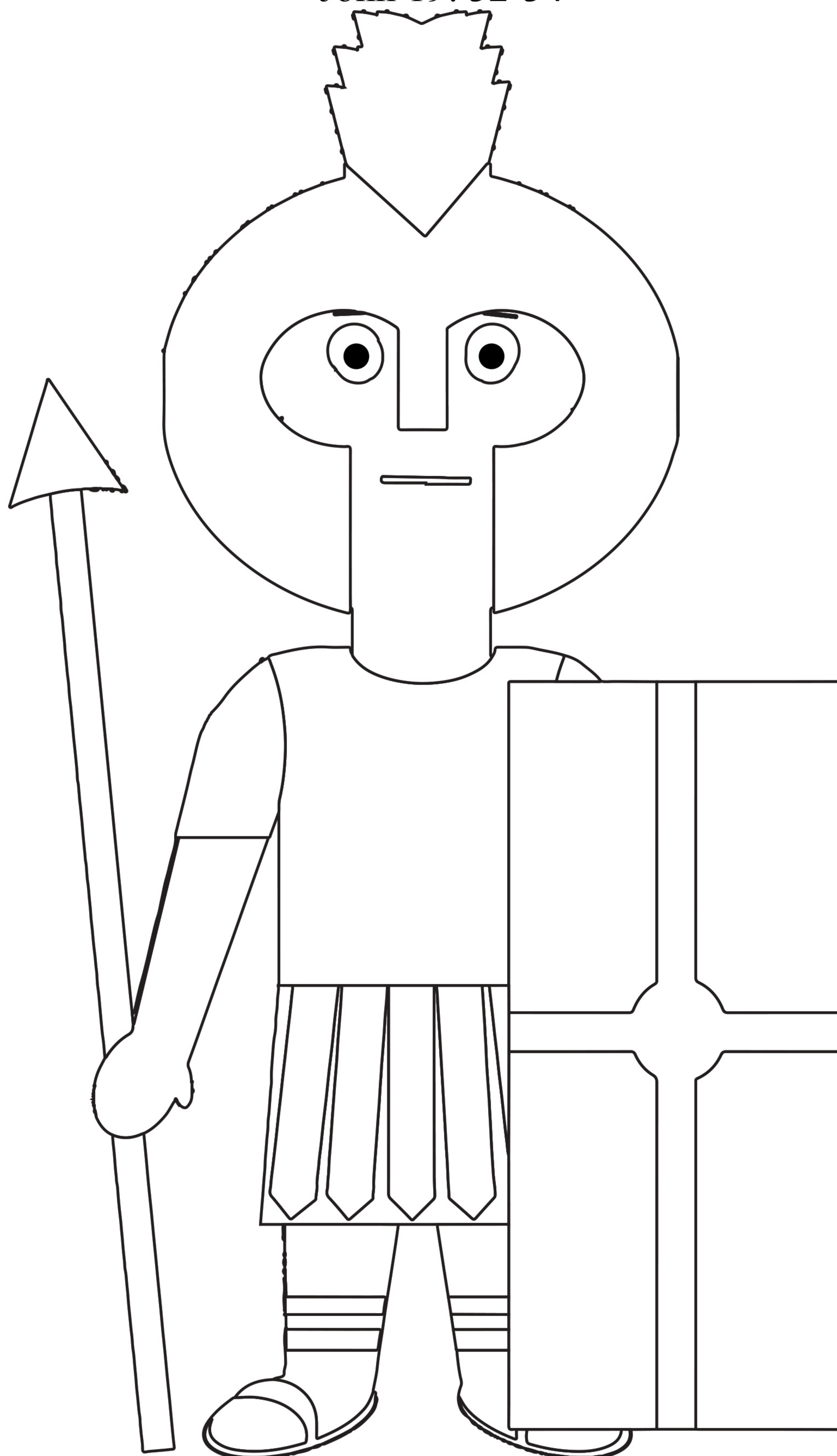

When it was evening, there came a rich man from Arimathea, named Joseph, who also was a disciple of Jesus. He went to Pilate and asked for the body of Jesus. Then Pilate ordered it to be given to him. And Joseph took the body and wrapped it in a clean linen shroud and laid it in his own new tomb, which he had cut in the rock. And he rolled a great stone to the entrance of the tomb and went away.

Matthew 2:57-60

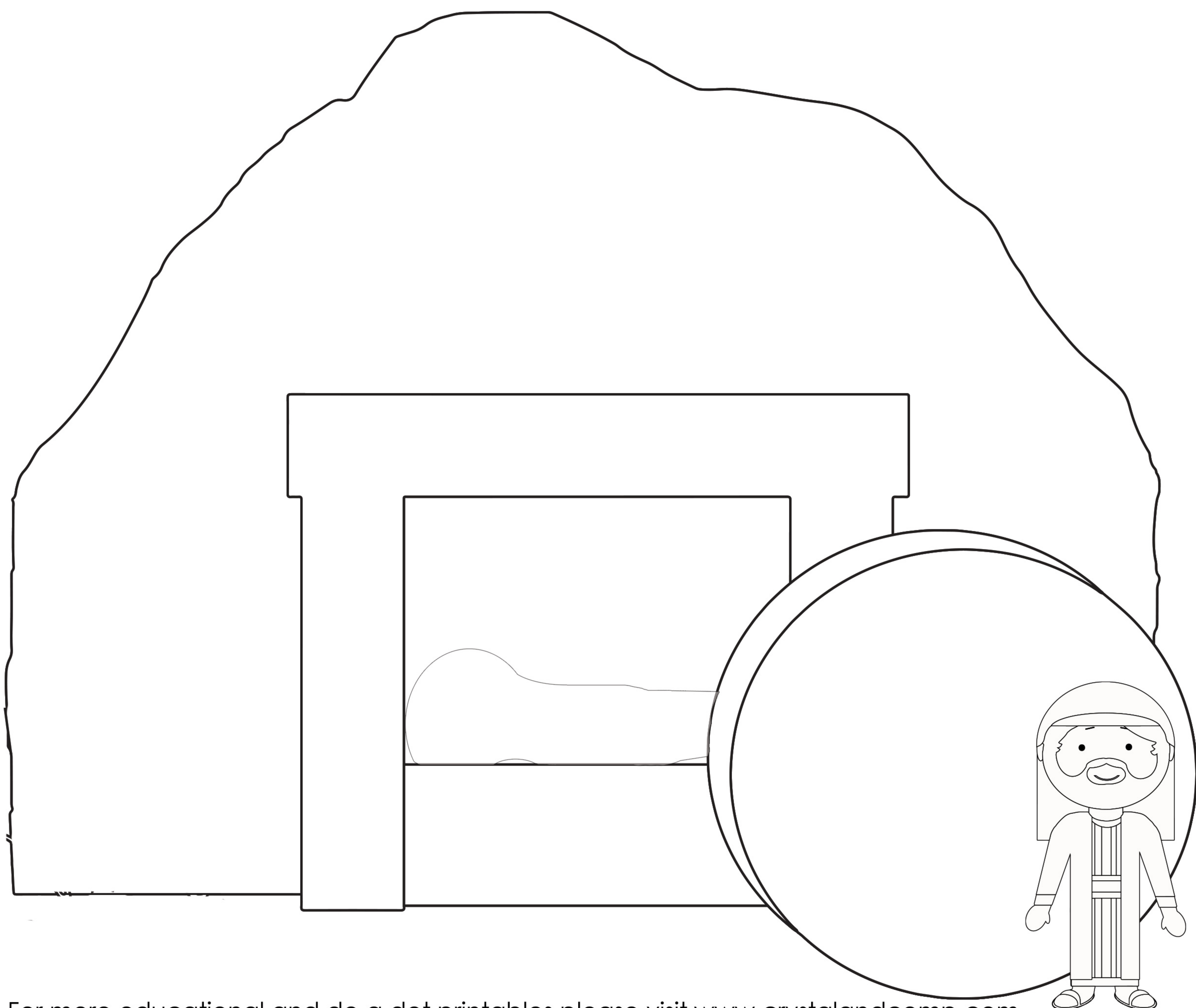

And behold, there was a great earthquake, for an angel of the Lord descended from heaven and came and rolled back the stone and sat on it. His appearance was like lightning, and his clothing white as snow. And for fear of him the guards trembled and became like dead men.

Matthew 28: 2-4

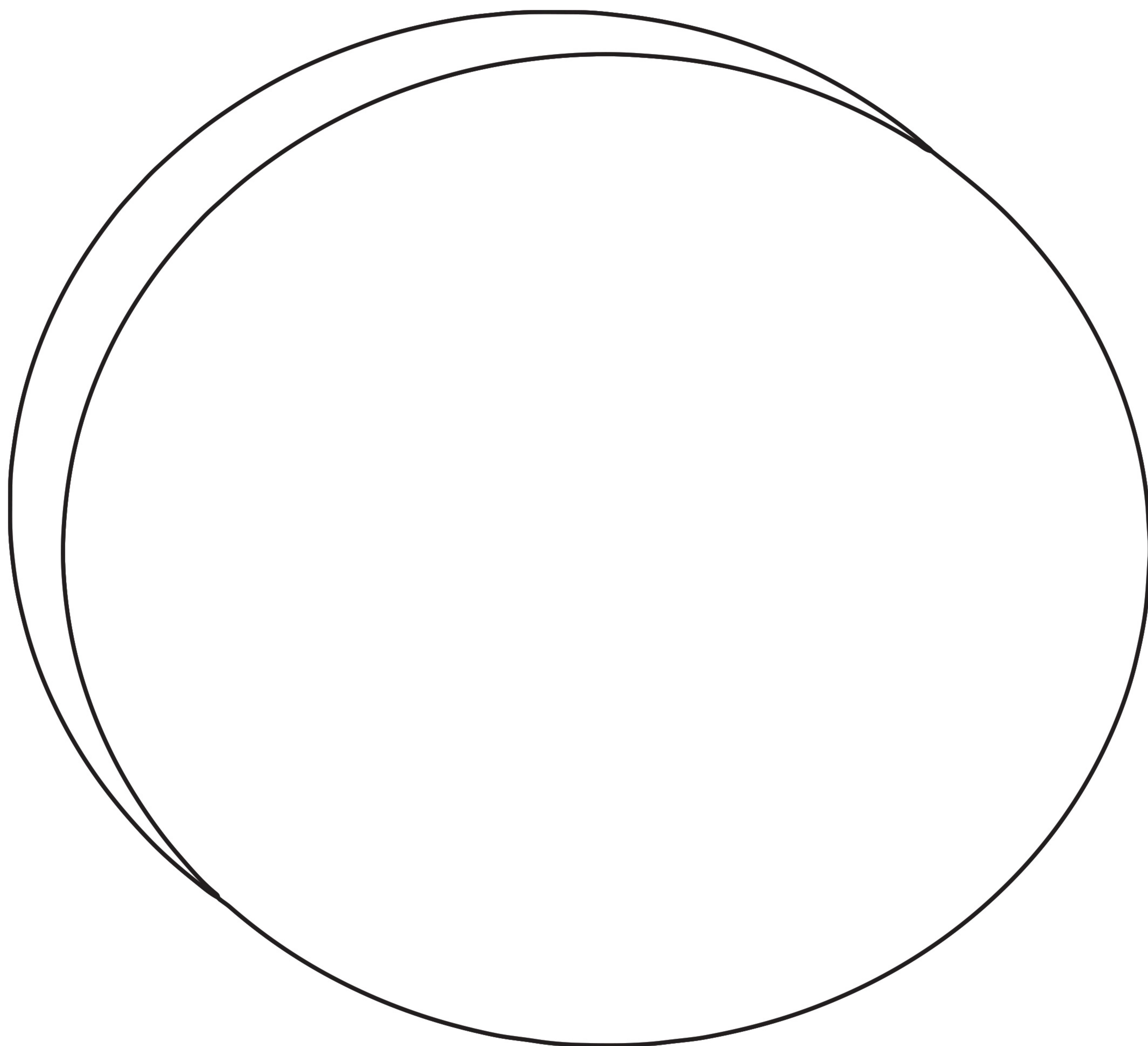

But the angel said to the woman, “Do not be afraid, for I know that you seek Jesus who was crucified. He is not here, for He has risen, as He said. Come, see the place where He lay.”

Matthew 28:5-6

